

Let there be Light



TRANSITIONS
Sunrooms
by LIVINGSPACE SUNROOMS^{LLC}



*Open up your home
to the Outdoors*

WITH A TRANSITIONS SUNROOM



STUDIO



Roof Style: Studio | Colors: European White | Knee Wall Style: Glass | 2 Lite Slider Windows | Options: Glass Transoms

Roof Style: Cathedral | Colors: European White | Full Length Picture Windows | Options: Glass Gable; Glass Transoms

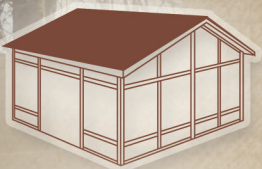

CATHEDRAL



*COVER Roof Style: Cathedral | Colors: Clay Interior | Knee Wall Style: Glass
2 Lite Slider Windows | Options: Glass Gable; Glass Transoms*



Roof Style: Studio | Colors: European White | Knee Wall Style: EcoGreen
2 Lite Slider Windows | Options: Glass Transoms



Roof Style: Cathedral | Colors: Tan | Knee Wall Style: Glass
2 Lite Slider Windows | Options: Gable Glass; Entry Door



Roof Style: Integrated | Colors: Tan | Full Length Picture Windows
Options: Glass Transoms

A Range of Options FOR EVERY TASTE & NEED

Transitions offers a wide range of structural and decorative options to help you put together the perfect room for your family. In addition to the options listed here, we can customize your room to nearly any requirement.

If you can dream it, we can do it.

FROM THE FIRST DAY
THIS WILL BE YOUR NEW

Favorite Room

OPEN UP YOUR HOUSE

If you're tired of looking at walls in your house, a sunroom is a wonderful solution. Now you can have the vistas and natural sunlight of the outdoors in the comfort of your own home. Beautiful, durable and low maintenance, a Transitions sunroom will create an open environment unlike any other room in your house. Our sunrooms are entirely custom designed and fabricated for your specific space; and our range of exterior and interior options will allow the new addition to blend pleasantly with any architectural style or interior décor.

LIVE LARGER

Expandable and upgradeable, a Transitions sunroom will provide year round comfort and enjoyment for many years to come. Whatever you do at home, you'll enjoy doing it more in your new Transitions sunroom. Filled with natural light, it makes a fantastic art studio, hobby or craft room. Children or grandchildren will love this space as a play room. It works as a library or quiet reading room to get away from it all or take a nap. At breakfast, enjoy the early morning light with your daily paper and a cup of coffee. You'll be absolutely amazed at how both you and your plants will blossom and thrive in this light-filled environment. Or, it may become an all purpose room, since every member of your family will want to spend time there. Whatever your use, from the first moment you set foot in it, this will be your new favorite room! A Transitions sunroom doesn't just expand your floor plan – *it expands your lifestyle.*

PROTECT YOUR

HOME INVESTMENT

If you've considered moving, but found the market unfavorable, a sunroom is a great way to expand your living space at a reasonable cost. Transitions offers the best built, highest quality sunroom system in the industry, with a lifetime limited warranty. Not only will it open up new vistas and relieve crowding, a Transitions sunroom is a high value investment in your home – one which will stay looking new and retain its value for the lifetime of your home.



Roof Style: Studio | Colors: European White | Knee Wall Style: Solid
2 Lite Slider Windows

ROOF STYLES

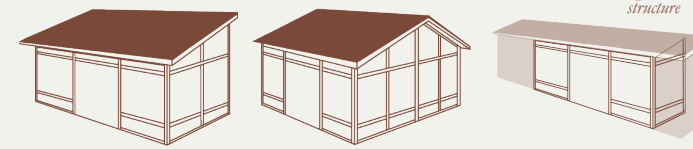

Studio

Cathedral

Integrated

KNEE WALL STYLES

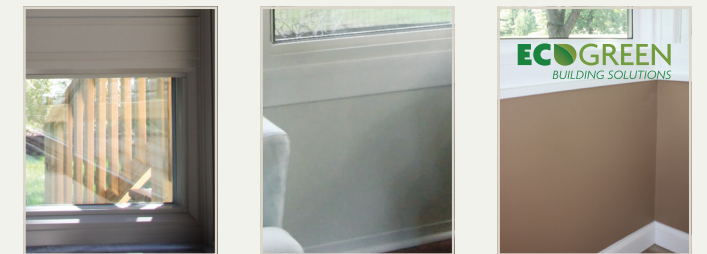

Glass

Solid

EcoGreen

COLORS

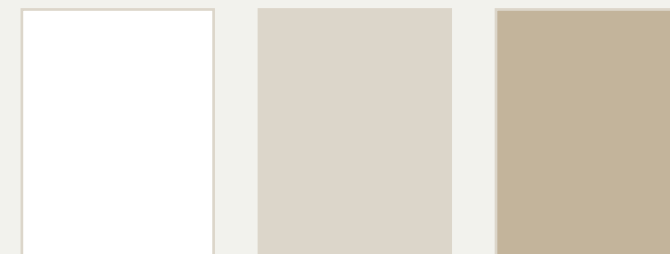

European White

Tan

Clay

DOOR STYLES

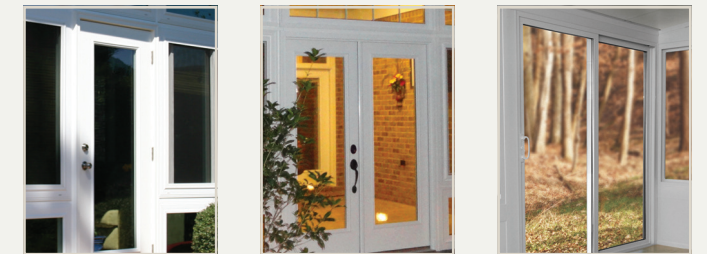

Single

French

Sliding

WINDOW STYLES

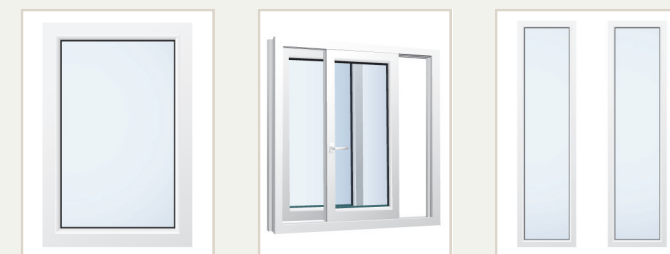

Picture

2 Lite Slider

Sidelights

ADDITIONAL OPTIONS



Ceiling Fans

Electrical Outlets

Climate Control

ALL SUNROOMS ARE NOT BUILT THE SAME

Most sunrooms on the market look great and perform great – when they’re new. But five or ten years later, most of those same sunrooms start to develop leaks, gaps, rust, mold or broken parts. You’ve heard the stories. And a sunroom isn’t like a new set of drapes – you can’t just take it down and start over again without a significant cost. That makes a sunroom not just a decorative addition, but an investment in your home – one which can increase or, if your sunroom deteriorates, even decrease its value over the years.

Transitions offers the highest quality sunroom available. From the inside out, superior materials, more thoughtful engineering and precise manufacturing serve to minimize or eliminate the typical problems associated with add-on sunrooms.

A Transitions sunroom will add value to your home from the moment you install it and still hold that value twenty years later. For most people, a home is one of the biggest investments of a lifetime – protect your investment with the best quality addition you can buy.

QUALITY STARTS IN THE DETAILS:

3 REASONS TRANSITIONS IS A BETTER INVESTMENT VALUE FOR YOUR HOME

1 SUPERIOR MATERIALS

STRONGER STRUCTURAL PARTS

Where other manufacturers use standard aluminum for structural parts, Transitions Sunrooms use a high temper aircraft aluminum alloy with ribbed reinforcement - the strongest in the industry. Our dual hollow load bearing “Hurricane Header” will easily withstand gulf coast storms or heavy midwest snow loads with spans much greater than typical sunrooms, giving space for larger window and door openings.

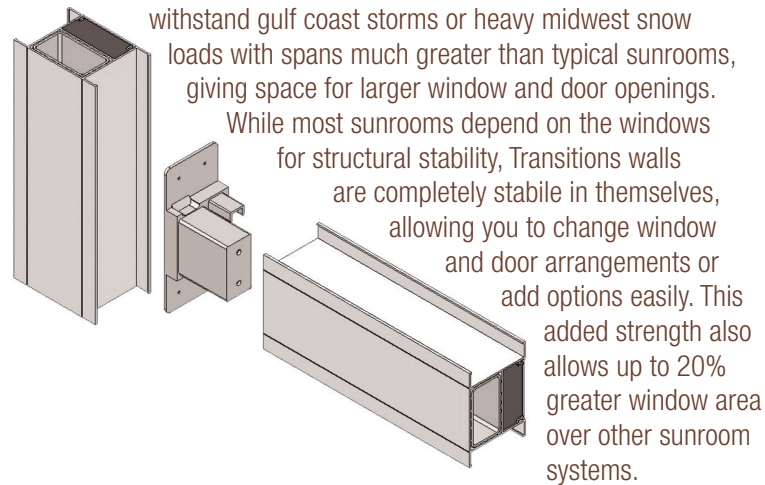

While most sunrooms depend on the windows for structural stability, Transitions walls are completely stable in themselves, allowing you to change window and door arrangements or add options easily. This added strength also allows up to 20% greater window area over other sunroom systems.

PVCu CLADDING

Other manufacturers use painted aluminum which scratches, sweats, shrinks and expands with the temperature, causing gaps for heat and water leaks. All Transitions structural aluminum parts are clad with virgin PVCu (not ground from scrap) which is treated with Titanium Dioxide (protects PVCu from damaging UV radiation). The effects of thermal expansion and contraction are absorbed, avoiding unsightly problematic gaps. Our PVCu cladding is 700 times more thermally efficient than thermally improved aluminum and protects the structural alloy from the punishment of the

weather. It won’t yellow or crack; and it’s the same color all the way through, not coated with a surface color, so scratches don’t show.

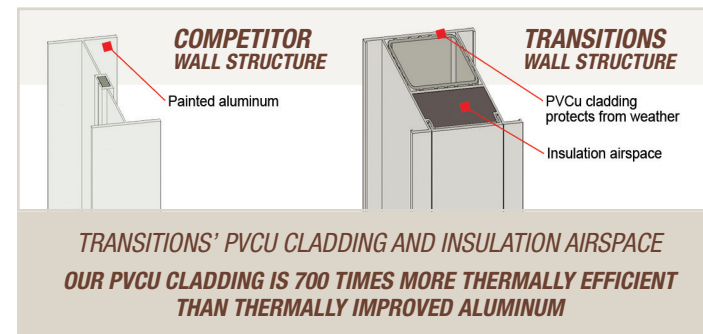

HIGH PERFORMANCE GLASS

Transitions Sunrooms use some of the highest performing insulated glass system in the industry, with insulating properties more than 5 times that of standard sunroom glass. Our available Low E2 and Low E3 glass uses special coatings which reflect heat back inside in the winter and reflect solar energy away in the summer, all while minimizing damaging UV rays which cause furnishings to fade.

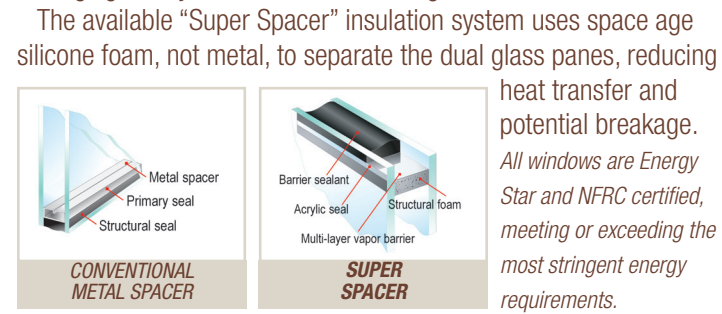

2 SUPERIOR ENGINEERING

UNIQUE INTERLOCKING CONNECTION SYSTEM

Our patented interlocking connection system is made of structural fiberglass reinforced Amilon Composite. This space age material creates a strong joint that reduces expansion and contraction. The interlocking joints are similar to the Mortise and Tenon system in a handcrafted Amish barn. This ensures a precision fit and provides much greater strength and stability than standard zip screw connections. This precision interlock means no “bending to fit” during installation, and eliminates exposed screws, bolts, and fasteners, providing a cleaner look.

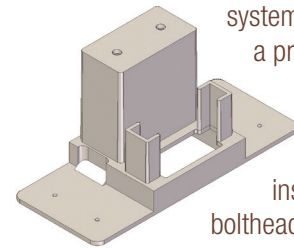

ALL CUSTOM SIZED WINDOWS AND WALL DESIGNS

Unlike most sunrooms, all Transitions wall systems and windows are custom manufactured to order. There are no stock panels, stock sizes or opaque “filler panels” to fill in gaps. This can increase the amount of glass by 20% over stock sized windows and allow for limitless design possibilities. All the windows in your wall will be custom size, as will all the structural members between windows. The whole width of your sunroom will have a pleasing, symmetrical look and your view will be unhindered.



DESIGNED FOR FLEXIBILITY

The Transitions system is engineered to accept all kinds of features and options, including lighting accents, ceiling fans, window treatments, and even “doggie door” panels. Transitions walls have built-in access areas to run electric, phone, cable or internet for a cleaner interior look. The system can accommodate three different door styles (single, French or sliding) and four window styles (picture, sidelights, 2 lite slider, or 3 lite slider). If you’re on a budget, you can get the room size you want now and easily add upgrades and options later.

ENERGY EFFICIENT OPTIONS

Transitions offers the most energy efficient sunroom system options available: Low E2 and Low E3 glass, Super Spacer, and the EcoGreen roof, deck, and wall system. EcoGreen uses green building technology to provide unsurpassed energy efficiency and structural

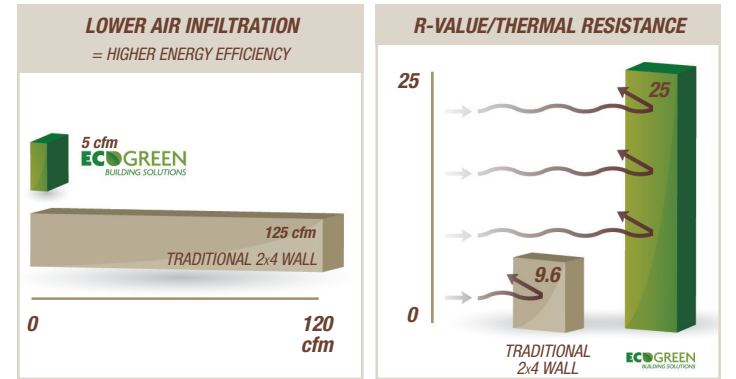

integrity, providing a comfortable and secure environment all year round. In addition, EcoGreen systems offer a wide range of design and finish options to match your taste and the decor of your home.

FULL SCREENS

Transitions windows have full screens allowing either sash to operate, without opening the sunroom to insects or other pests. Most sunroom windows have half screens because only half of each window can open.

3 SUPERIOR MANUFACTURING

INDIVIDUALLY DESIGNED & PRECISION FABRICATED

To start with, each Transitions sunroom is individually designed and engineered with CAD. No off-the-shelf package, no stock sizes, no mixing and matching. Then the parts are precision fabricated in a controlled environment using computer guided saws and positioning systems.

THE PERFECT FIT

When each piece is fabricated, it is individually labeled and logged into our computer tracking system to make sure all parts are accounted for, the right size, and perfect fit. Most manufacturers ship long parts to be cut and fit as the sunroom is being laid out, designed, and assembled on site, inviting errors in cutting and fitting by installers using crude “chop boxes” and hand tools.



QUICK INSTALLATION

The combination of professional design and our precision manufacturing means Transitions Sunrooms can be constructed on your home quickly and seamlessly. Most Transitions sunrooms are constructed in as little as a week and create very little disruption to the household routine.

THIS WILL BE YOUR NEW *Favorite Room*

We're in our sunroom all year long - it gives us a really great view of our lake. With all the light, it's a great room for plants, and it stays warm in the winter. It's really state of the art - I haven't seen anything better anywhere! It's thoroughly insulated and the workmanship is first class. The price was right and installation went quickly and smoothly. I actually enjoyed having the installation team around - they were really nice. Visitors are always so impressed when they see our new sunroom.

Everything came together perfectly - my only regret is that I didn't have 2 rooms added!

Mary Vandermeer, Grand Rapids

We looked at eight different building systems before we decided on your sunroom, but we definitely ended up making the right choice! There's so much attention to detail, it was easily the best quality product we saw. We love the new sunroom - we practically live in it. It's our relaxing room, our TV room, our entertaining room. Even with all the glass, it's very quiet. The windows are tight and easy to operate - they slide in either direction. The installation took only a few days, and we watched the whole process carefully. It was our builder's first LivingSpace Sunrooms installation, and he couldn't believe how easy it was to install. It's wonderful - we have absolutely no complaints at all.

- PAUL ENEY, LELAND

